

# Ethernet DC/DC Converter EPC1008P & EPC1008H

- Features**
- 75 % Typical efficiency at full load @ nominal input voltage
  - Unregulated Output
  - Input / Output Isolation
  - Input filter to reduce input ripple current
  - Designed for low common mode noise

## Electrical Specifications

\*Note : Package with G = Surface Mount Device, †† : E1,E1-G,E4,E4-G,E11,Q,Q1, N4-G

| PCA P/N  | STD PKG | Optional Packages | Input Voltage V | Output Voltage V | Output Current mA Max. | Output Ripple & Noise @ 20 MHz BW mV p-p | Isolation Vrms |
|----------|---------|-------------------|-----------------|------------------|------------------------|--|----------------|
| EPC1008P | E       | E-G*, F2,N,††     | 12.0            | 9 ± 5%           | 200 Max.               | 100 Max.                                 | 500            |
| EPC1008H | E1      | E1-G*,N,Q1        | 12.0            | 9 ± 5%           | 200 Max.               | 100 Max.                                 | 2000           |

### Pin Connections for E\*\*

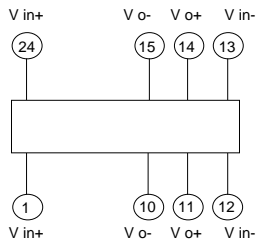

### Pin Connections for E1

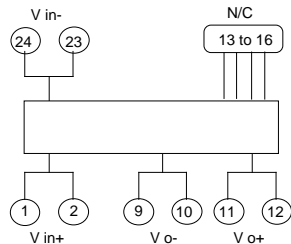

### Pin Connections for E4

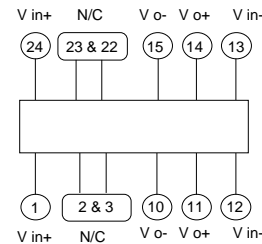

### Pin Connections for F2

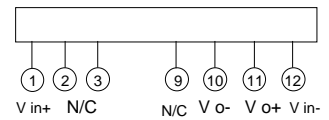

### PACKAGE E

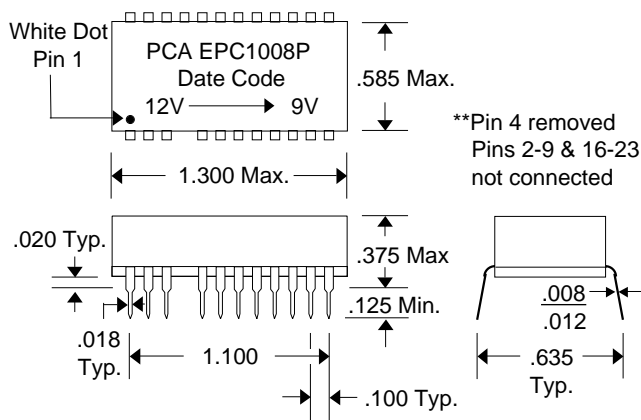

### PACKAGE F2

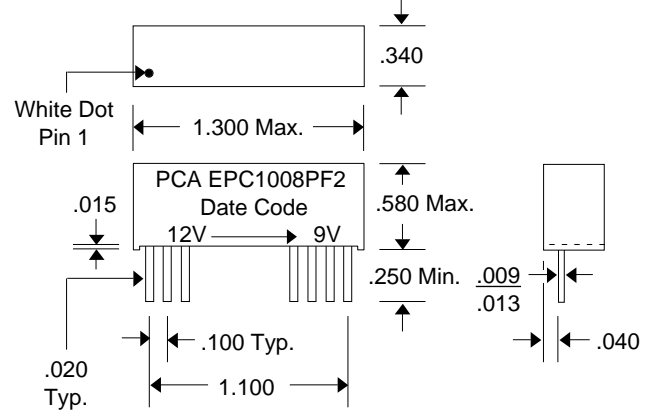

### PACKAGE E1

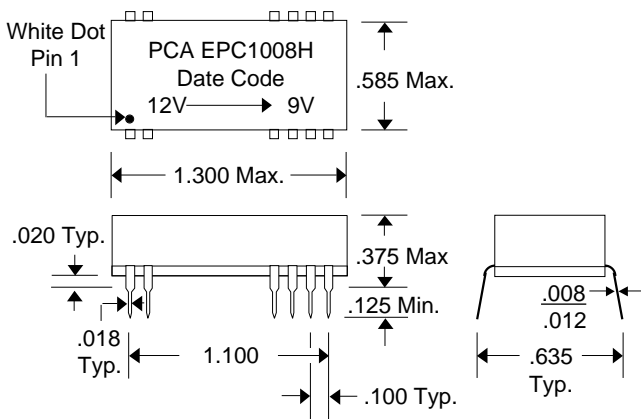

### PACKAGE E4

